

BIXOLON®

User's Manual

SRP-350/352plusA&C

Thermal Printer

Rev. 1.11

<http://www.bixolon.com>

■ Safety Precautions

In using the present appliance, please keep the following safety regulations in order to prevent any hazard or material damage.



WARNING

Violating following instructions can cause serious injury or death.

Do not plug several products in one multi-outlet.

- This can provoke over-heating and a fire.
- If the plug is wet or dirty, dry or wipe it before usage.
- If the plug does not fit perfectly with the outlet, do not plug in.
- Be sure to use only standardized multi-outlets.

PROHIBITED

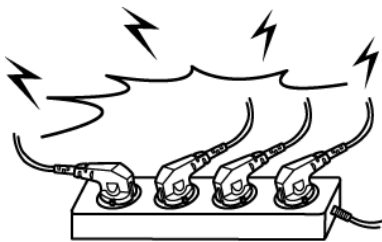

You must use only the supplied adapter.

- It is dangerous to use other adapters.

PROHIBITED



Do not pull the cable to unplug.

- This can damage the cable, which is the origin of a fire or a breakdown of the printer.

PROHIBITED

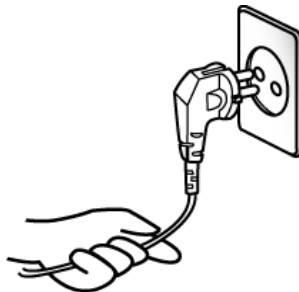

Keep the plastic bag out of children's reach.

- If not, a child may put the bag on his head.

PROHIBITED



Do not plug in or unplug with your hands wet.

- You can be electrocuted.

PROHIBITED

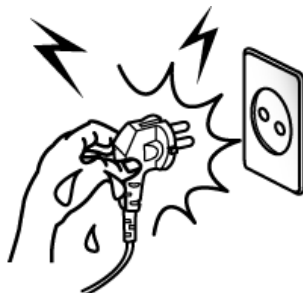

Do not bend the cable by force or leave it under any heavy object.

- A damaged cable can cause a fire.

PROHIBITED

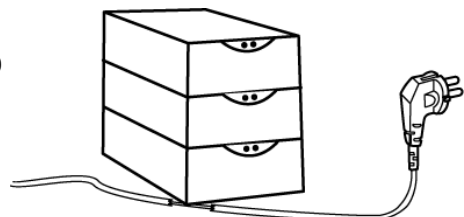



CAUTION

Violating following instructions can cause slight wound or damage the appliance.

If you observe a strange smoke, odor or noise from the printer, unplug it before taking following measures.

- Switch off the printer and unplug the set from the mains.
- After the disappearance of the smoke, call your dealer to repair it.

TO UNPLUG



Keep the desiccant out of children's reach.

- If not, they may eat it.

PROHIBITED



Install the printer on the stable surface.

- If the printer falls down, it can be broken and you can hurt yourself.

PROHIBITED

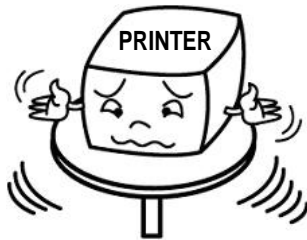

Use only approved accessories and do not try to disassemble, repair or remodel it for yourself.

- Call your dealer when you need these services.
- Do not touch the blade of auto cutter.

DISASSEMBLING PROHIBITED

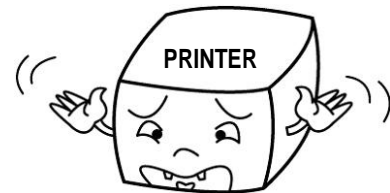

Do not let water or other foreign objects in the printer.

- If this happened, switch off and unplug the printer before calling your dealer.

PROHIBITED



Do not use the printer when it is out of order. This can cause a fire or an electrocution.

- Switch off and unplug the printer before calling your dealer.

TO UNPLUG



■ Warning - U.S.A

This equipment has been tested and found to comply with the limits for a Class A digital device pursuant to Part 15 of the FCC Rules. These limits are designed to provide reasonable protection against harmful interference when the equipment is operated in a commercial environment. This equipment generates uses, and can radiate radio frequency energy and, if not installed and used in accordance with the instruction manual, may cause harmful interference to radio communications. Operation of this equipment in a residential area is likely to cause harmful interference in which case the user will be required to correct the interference at his own expense.

■ Notice - Canada

This Apparatus complies with class "A" limits for radio interference as specified in the Canadian department of communications radio interference regulations.

Get appareil est conforme aux normes class "A" d'interference radio tel que specifier par ministre canadien des communications dans les reglements d'interference radio.

■ Caution

Some semiconductor devices are easily damaged by static electricity. You should turn the printer "OFF", before you connect or remove the cables on the rear side, in order to guard the printer against the static electricity. If the printer is damaged by the static electricity, you should turn the printer "OFF".

■ Waste Electrical and Electric Equipment (WEEE)



This marking shown on the product or its literature, indicates that it should not be disposed with other household wastes at the end of its working life. To prevent possible harm to the environment or human health from uncontrolled waste disposal, please separate this from other types of wastes and recycle it responsibly to promote the sustainable reuse of material resources. Household users should contact either the retailer where they purchased this product, or their local government office, for details of where and how they can take this item for environmentally safe recycling. Business users should contact their supplier and check the terms and conditions of the purchase contract. This product should not be mixed with other commercial wastes for disposal.

■ Label Material

* Control Label: PC

* Other Labels: PET

■ Introduction

The SRP-350/352plus Roll Printer are designed for use with electronic instruments such as system ECR, POS, banking equipment, computer peripheral equipment, etc. The main features of the printer are as follows:

1. High speed printing : 47.28/52 (1/6" Feed) lines per second.
2. Low noise thermal printing.
3. The data buffer allows the unit to receive print data even during printing.
4. Peripheral units drive circuit enables control of external devices such as cash drawer.
5. Characters can be scaled up to 64 times compared to it's original size.
6. Bar code printing is possible by using a bar code command.
7. Different print densities can be selected by DIP switches.

Please be sure to read the instruction in this manual carefully before using your new SRP-350/352plus.

※ NOTE

- The socket-outlet shall be near the equipment and it shall be easy accessible.

※ All specifications are subjected to change without notice.

■ Table of Contents

1. Setting Up the Printer 7
1-1 Unpacking..... 7
1-2 Connecting the Cables 8
 1-2-1 Serial Interface (RS-232C) 8
 1-2-2 Parallel Interface (IEEE1284) 9
 1-2-3 USB2.0 Interface 10
1-3 Connecting the Drawer 10
1-4 Setting the Dip Switches..... 11
 1-4-1 Serial Interface (RS-232C)11
 1-4-2 Parallel & USB2.0 Interface11
 1-4-3 Auto Cutter Enable / Disable selection 12
1-5 Setting the Memory Switches 13
1-6 Installing or Replacing the Paper Roll..... 15
1-7 Adjustments and Settings 17
1-8 Using the Printer 17
1-9 Connecting the computer..... 18
1-10 Connecting the Power Supply..... 18

2. Self test..... 19

3. Hexadecimal Dumping 20

4. Specification 21

5. Appendix 22
5-1 Cleaning Printer 22

1. Setting Up the Printer

1-1 Unpacking

Your printer box should include these items. If any items are damaged or missing, please contact your dealer for assistance.

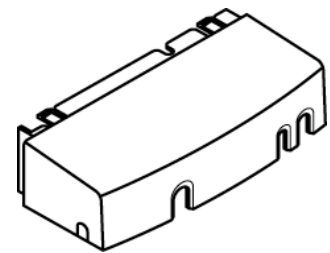

Cover Cable

SRP-350/352plusC

SRP-350/352plusA

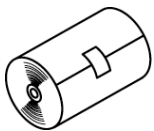

Roll Paper

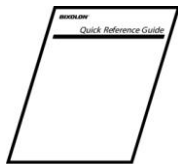

Manual

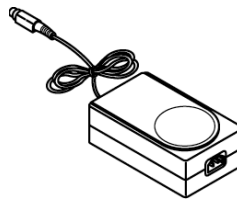

AC Adapter



Power Cord



CD

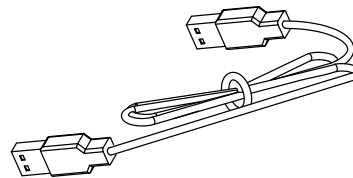

USB A-A CABLE

1-2 Connecting the Cables

You can connect up the three cables to the printer. They all connect to the connector panel on the back of the printer, which is shown below:

※ NOTE

- Before connecting any of the cables, make sure that both the printer and the host are turned off.

1-2-1 Serial Interface (RS-232C)

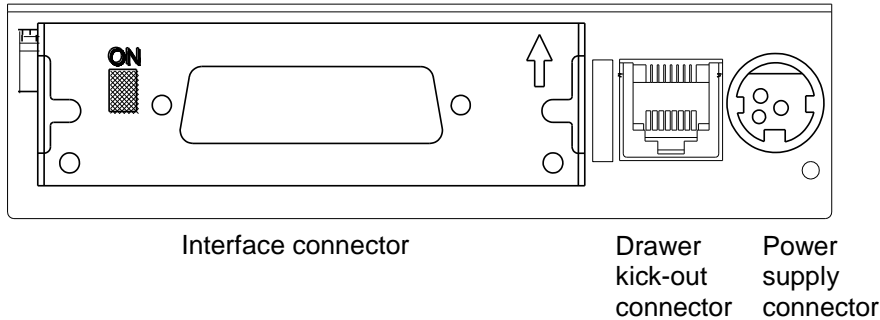

※ When the Dip Switch is “ON” on the Serial Interface Board, DTR and RTS are connected each other.

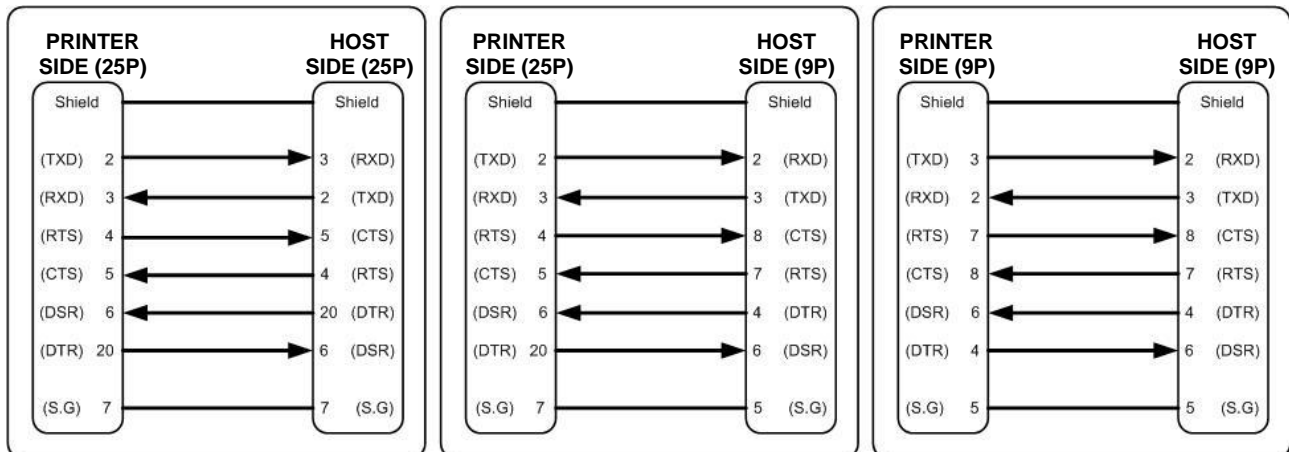

Pin No.	Signal name	Direction	Function
1	FG	-	Frame Ground
2	TxD	Output	Transmit Data
3	RxD	Input	Receive Data
4	RTS	Output	Ready To Send
5	CTS	Input	Clear To Send
6	DSR	Input	Data Set Ready
7	SG	-	Signal Ground
20	DTR	Output	Data Terminal Ready
Shield	FG	-	Frame Ground

1-2-2 Parallel Interface (IEEE1284)

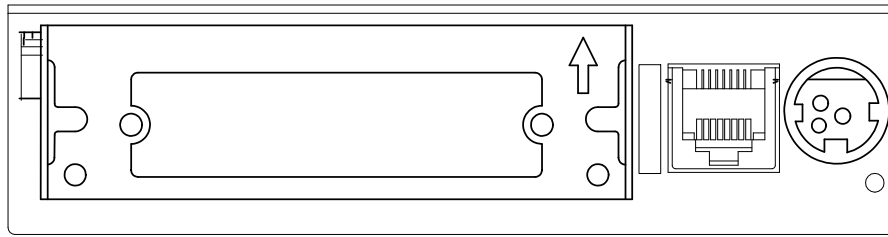

Interface connector

Drawer
kick-out
connector

Power
supply
connector

Pin No.	Source	Compatibility Mode	Nibble Mode	Byte Mode
1	Host	nStrobe	HostClk	HostClk
2	Host / Printer	Data 0 (LSB)	-	Data 0 (LSB)
3	Host / Printer	Data 1	-	Data 1
4	Host / Printer	Data 2	-	Data 2
5	Host / Printer	Data 3	-	Data 3
6	Host / Printer	Data 4	-	Data 4
7	Host / Printer	Data 5	-	Data 5
8	Host / Printer	Data 6	-	Data 6
9	Host / Printer	Data 7 (MSB)	-	Data 7 (MSB)
10	Printer	nAck	PtrClk	PtrClk
11	Printer	Busy	PtrBusy /Data3,7	PtrBusy
12	Printer	Perror	AckDataReq/Data2,6	AckDataReq
13	Printer	Select	Xflag /Data1,5	Xflag
14	Host	nAutoFd	HostBusy	HostBusy
15		NC	NC	NC
16		GND	GND	GND
17		FG	FG	FG
18	Printer	Logic-H	Logic-H	Logic-H
19~30		GND	GND	GND
31	Host	nInit	nInit	nInit
32	Printer	nFault	nDataAvail /Data0,4	nDataAvail
33		GND	ND	ND
34	Printer	DK_Status	ND	ND
35	Printer	+5V	ND	ND
36	Host	nSelectIn	1284-Active	1284-Active

1-2-3 USB2.0 Interface

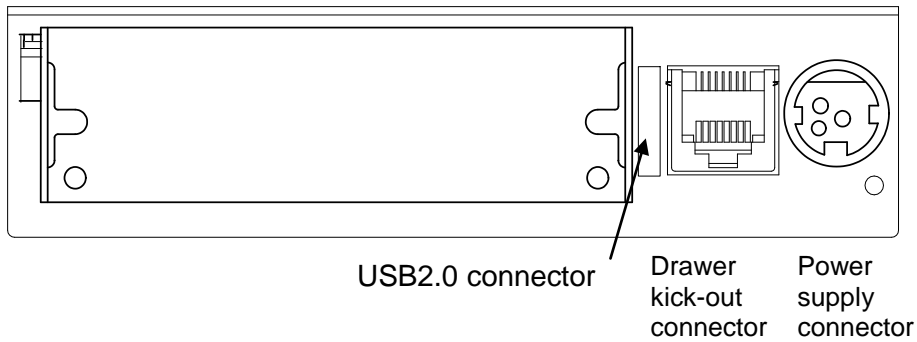

Pin No.	Signal Name	Assignment (Color)	Function
Shell	Shield	Drain Wire	Frame Ground
1	VBUS	Red	Host Power
2	D-	White	Data Line(D-)
3	D+	Green	Data Line(D+)
4	GND	Black	Signal Ground

1-3 Connecting the Drawer

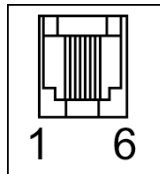

※ WARNING

- Use a drawer that matches the printer specification. Using an improper drawer may damage the drawer as well as the printer.

※ CAUTION

- Do not connect a telephone line to the drawer kick-out connector; otherwise the printer and the telephone line may be damaged.

Plug the drawer cable into the drawer kick-out connector on the back of the printer next to the power supply connector.

Pin No.	Signal name	Direction
1	Frame ground	-
2	Drawer kick- out drive signal 1	Output
3	Drawer open/close signal	Input
4	+24V	-
5	Drawer kick- out drive signal 2	Output
6	Signal ground	-

※ Drawer Port is 24Vdc/2.5A Output rating, Class 1.

1-4 Setting the Dip Switches**1-4-1 Serial Interface (RS-232C)**• **DIP Switch 1**

SW	Function	ON	OFF	Default
1-1	Auto Line Feed	Enable	Disable	OFF
1-2	Handshaking	XON/XOFF	DTR/DSR	OFF
1-3	Data Length	7bits	8bits	OFF
1-4	Parity Check	Yes	No	OFF
1-5	Parity Selection	EVEN	ODD	OFF
1-6	Baud Rate Selection (bps)	Refer to the following table 1		OFF
1-7				ON
1-8				OFF

• **DIP Switch 2**

SW	Function	ON	OFF	Default
2-1	Reserved	-	-	OFF
2-2	Internal bell control	Internal bell disable	Internal bell enable	OFF
2-3	Auto Cutter	Disable	Enable	OFF
2-4	Reserved	-	-	OFF
2-5	Print Density	Refer to the following table 2		OFF
2-6				OFF
2-7				OFF
2-8	Near-End Sensor Status	Disable	Enable	OFF

1-4-2 Parallel & USB2.0 Interface• **DIP Switch 1**

SW	Function	ON	OFF	Default
1-1	Auto Line Feed	Enable	Disable	OFF
1-2 ~ 1-6	Reserved	-	-	OFF
1-7	Reserved	-	-	ON
1-8	Reserved	-	-	OFF

• **DIP Switch 2**

SW	Function	ON	OFF	Default
2-1	Reserved	-	-	OFF
2-2	Internal bell control	Internal bell disable	Internal bell enable	OFF
2-3	Auto Cutter	Disable	Enable	OFF
2-4	Reserved	-	-	OFF
2-5	Print Density	Refer to the following Table 2		OFF
2-6				OFF
2-7				OFF
2-8	Near-End Sensor Status	Disable	Enable	OFF

SRP-350/352plusA&C

• Table 1 – Baud rate (bps) Selection

Transmission Speed	1-6	1-7	1-8	Default
2400	ON	OFF	OFF	9600
4800	ON	OFF	ON	
9600	OFF	ON	OFF	
19200	OFF	OFF	OFF	
38400	OFF	ON	ON	
57600	OFF	OFF	ON	
115200	ON	ON	ON	

• Table 2 – Print Density Selection

2-5	2-6	2-7	Print Density (Mono color)	Default
ON	ON	Reserved	1(Light)	2
OFF	OFF	Reserved	2	
ON	OFF	Reserved	3	
OFF	ON	Reserved	4(Dark)	
2-5	2-6	2-7	Print Density (Two colors)	Default
ON	ON	ON	80%	100%
ON	ON	OFF	90%	
OFF	OFF	ON	95%	
OFF	OFF	OFF	100%	
ON	OFF	ON	105%	
ON	OFF	OFF	110%	
OFF	ON	ON	120%	
OFF	ON	OFF	130%	

1-4-3 Auto Cutter Enable / Disable selection

Dip Switch Set 2		
SW 2-3	ON	Auto Cutter Disabled
	OFF	Auto Cutter Enabled
Application	Ignores Auto Cutter error for continuous printing.	

1-5 Setting the Memory Switches

This printer has “Memory Switch” set which is software switches. Memory Switch set has “MSW1”, “MSW2”, “MSW8”, “MSW9” “Customize value”, “Serial communication condition”. “Memory Switch setting utility” can change the Memory Switch set to ON or OFF as shown in the table below. (default : all OFF)

※ NOTE

- The Memory Switch is available to be changed by three methods.
 - Memory Switch setting utility.
 - Control from BXL/POS command.

Settings of the Memory Switch are stored in the NV memory : therefore, even if the printer is turned off, the settings are maintained.

MSW1

Switch	Function	ON	OFF
1~8	Reserved	--	Fixed to OFF

MSW2

Switch	Function	ON	OFF
1	Font Selection	Font B (9 x 24)	Font A (12 x 24)
2	Auto Cutter Function	Full Cutting	Partial Cutting
3~8	Code Page Selection	Refer to following Table	

SRP-350/352plusA&C

MSW2-8	MSW2-7	MSW2-6	MSW2-5	MSW2-4	MSW2-3	Character Table	
OFF	OFF	OFF	OFF	OFF	OFF	Page 0	437 (USA, Standard Europe)
OFF	OFF	OFF	OFF	ON	OFF	Page 1	Katakana
OFF	OFF	OFF	ON	OFF	OFF	Page 2	850 (Multilingual)
OFF	OFF	OFF	ON	ON	OFF	Page 3	860 (Portuguese)
OFF	OFF	ON	OFF	OFF	OFF	Page 4	863 (Canadian-French)
OFF	OFF	ON	OFF	ON	OFF	Page 5	865 (Nordic)
OFF	OFF	ON	ON	OFF	OFF	Page 16	1252 (Latin I)
OFF	OFF	ON	ON	ON	OFF	Page 17	866 (Cyrillic #2)
OFF	ON	OFF	OFF	OFF	OFF	Page 18	852 (Latin 2)
OFF	ON	OFF	OFF	ON	OFF	Page 19	858 (Euro)
OFF	ON	OFF	ON	OFF	OFF	Page 21	862 (Hebrew DOS code)
OFF	ON	OFF	ON	ON	OFF	Page 22	864 (Arabic)
OFF	ON	ON	OFF	OFF	OFF	Page 23	Thai42
OFF	ON	ON	OFF	ON	OFF	Page 24	1253 (Greek)
OFF	ON	ON	ON	OFF	OFF	Page 25	1254 (Turkish)
OFF	ON	ON	ON	ON	OFF	Page 26	1257 (Baltic)
ON	OFF	OFF	OFF	OFF	OFF	Page 27	Farsi
ON	OFF	OFF	OFF	ON	OFF	Page 28	1251 (Cyrillic)
ON	OFF	OFF	ON	OFF	OFF	Page 29	737 (Greek)
ON	OFF	OFF	ON	ON	OFF	Page 30	775 (Baltic)
ON	OFF	ON	OFF	OFF	OFF	Page 31	Thai14
ON	OFF	ON	OFF	ON	OFF	Page 32	Hebrew Old code
ON	OFF	ON	ON	OFF	OFF	Page 33	1255 (Hebrew New code)
ON	OFF	ON	ON	ON	OFF	Page 34	Thai11
ON	ON	OFF	OFF	OFF	OFF	Page 35	Thai18
ON	ON	OFF	OFF	ON	OFF	Page 36	855 (Cyrillic)
ON	ON	OFF	ON	OFF	OFF	Page 37	857 (Turkish)
ON	ON	OFF	ON	ON	OFF	Page 38	928 (Greek)
ON	ON	ON	OFF	OFF	OFF	Page 39	Thai16
ON	ON	ON	OFF	ON	OFF	Page 40	1256 (Arabic)

MSW8

Switch	Function	ON	OFF
1~8	Reserved	--	Fixed to OFF

MSW9

Switch	Function	ON	OFF
1~8	Reserved	--	Fixed to OFF

MSW10 (Special Function 1)

Switch	Function	ON	OFF
1	External buzzer control (This functions operate only after cutting)	External buzzer enable	External buzzer disable
2~4	Reserved	--	Fixed to OFF
5	Printing width	2 inch	3 inch
6	2Color support	Enable	Disable
7~8	Reserved	--	Fixed to OFF

MSW11 (Special Function 2)

Switch	Function	ON	OFF
1~8	Reserved	--	Fixed to OFF

1-6 Installing or Replacing the Paper Roll

※ **NOTE**

- Be sure to use paper rolls that meet the specifications. Do not use paper rolls that have the paper glued to the core because the printer cannot detect the paper end correctly.

1-6-1 Make sure that the printer is not receiving data; otherwise, data may be lost.

1-6-2 Open the paper roll cover by pressing the cover-open button.

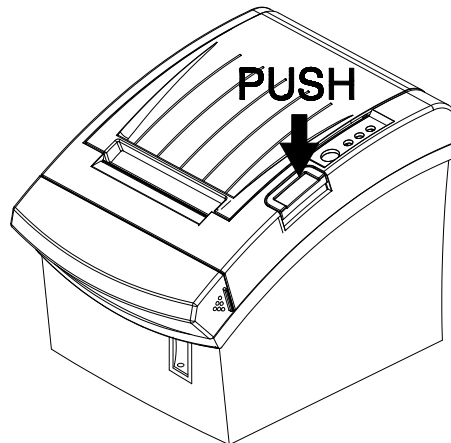

※ **NOTE**

- Do not open the print cover while the printer is operating. This may damage the printer.

1-6-3 Remove the used paper roll core if there is one.

1-6-4 Insert the paper roll as shown.

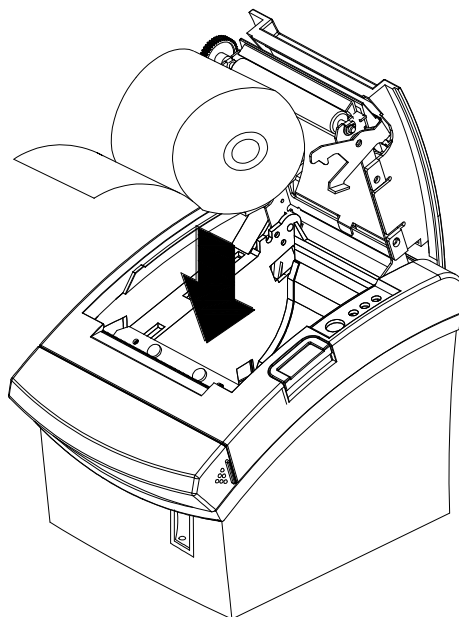

1-6-5 Be sure to note the correct direction that the paper comes off the roll.

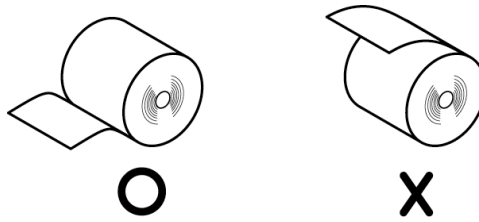

1-6-6 Pull out a small amount of paper, as shown. Then close the cover.

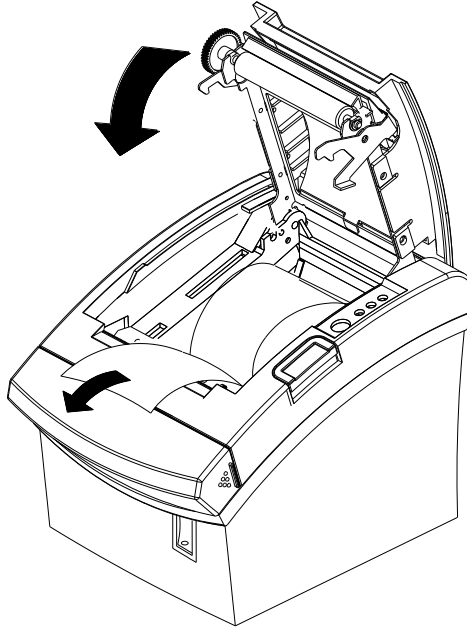

※ NOTE

- When closing the cover, press the center of printer cover firmly to prevent paper miss-loading.

1-6-7 Tear off the paper as shown.

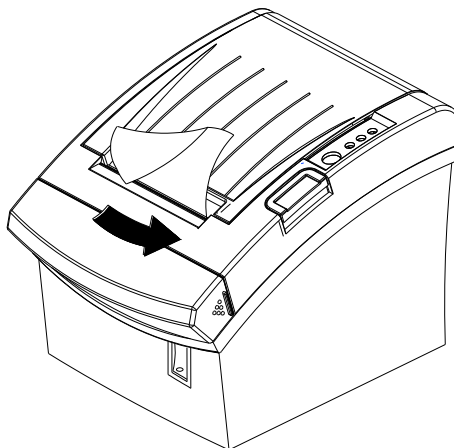

1-7 Adjustments and Settings

The SRP-350/352plus is set up at the factory to be appropriate for almost all users. It does, however, offer some settings for users with special requirements.

It has DIP switches that allow you to change communication settings, such as handshaking and parity check, as well as print density.

The SRP-350/352plus also has a near-end sensor for the paper. This can give you a warning when the paper is almost out. If you find that there is not enough paper remaining on the roll when the near-end sensor is triggered, you can change the near-end sensor setting. Rotate the near end sensor tab at front or rear position. (See the below figure)

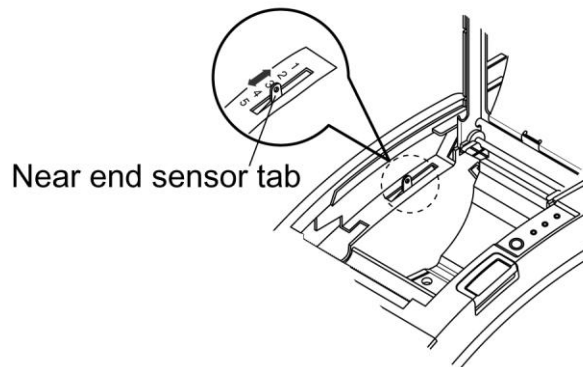

1-8 Using the Printer

Control Panel

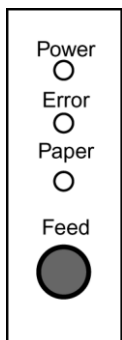

POWER

The POWER light is on whenever the printer is on.

ERROR

This indicates an error.

PAPER

This light indicates the near end of the paper roll. Install a new paper roll and the printer will continue printing. When the light blinks, it indicates the self-test printing standby state or macro execution Standby state when the macro execution command is used.

FEED

Press the FEED button once to advance paper one line. You can also hold down the FEED button to feed paper continuously.

1-9 Connecting the computer

You need an appropriate interface cable.

1-9-1 Plug the cable connector securely into the printer's interface connector.

1-9-2 Tighten the screws on both sides of the cable connector.

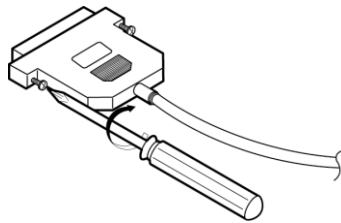

1-9-3 Attach the other end of the cable to the computer.

1-10 Connecting the Power Supply

※ CAUTIONS

- When connecting or disconnecting the power supply from the printer, make sure that the power supply is not plugged into an electrical outlet. Otherwise you may damage the power supply or the printer.

If the power supply's rated voltage and your outlet's voltage do not match, contact your dealer for assistance. Do not plug in the power cord. Otherwise, you may damage the power supply or the printer.

1-10-1 Make sure that the printer's power switch is turned off, and the power supply's power cord is unplugged from the electrical outlet.

1-10-2 Check the label on the power supply to make sure that the voltage required by the power supply matches that of your electrical outlet.

1-10-3 Plug in the power supply's cable as shown below. Notice that the flat side of the plug faces down.

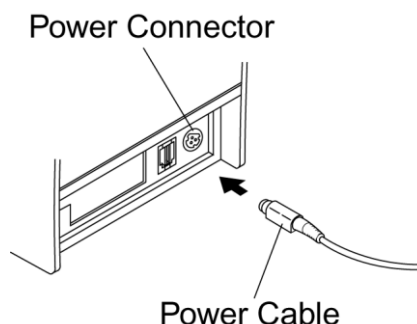

※ NOTE

- To remove the DC cable connector, make sure that the power supply's power cord is unplugged; then grasp the connector at the arrow and pull it straight out.

2. Self test

The self-test checks whether the printer has any problems. If the printer does not function properly, contact your dealer. The self-test checks the following;

2-1 Make sure paper roll has been installed properly.

2-2 Turn on the power while holding down the FEED button. The self-test begins.

2-3 The self-test prints the current printer status, which provides the control ROM version and the DIP switch setting.

2-4 After printing the current printer status, self-test printing will print the following, and pause (The PAPER LED light blinks).

**SELF-TEST PRINTING.
PLEASE PRESS THE FEED BUTTON.**

2-5 Press the FEED button to continue printing.

The printer prints a pattern using the built-in character set.

2-6 The self-test automatically ends and cuts the paper after printing the following.

***** COMPLETED *****

2-7 The printer is ready to receive data as soon as it completes the self-test.

3. Hexadecimal Dumping

This feature allows experienced users to see exactly what data is coming to the printer. This can be useful in finding software problems. When you turn on the hexadecimal dump function, the printer prints all commands and data in hexadecimal format along with a guide section to help you find specific commands.

To use the hexadecimal dump function, follow these steps.

3-1 After you make sure that the printer is off, open the cover.

3-2 Turn on the printer, while holding down the FEED button.

3-3 Close the cover, then the printer enters the hexadecimal dump mode.

3-4 Run any software program that sends data to the printer. The printer will print all the codes it receives in a two-column format. The first column contains the hexadecimal codes and the second column gives the ASCII characters that corresponds to the codes.

```
1B 21 00 1B 26 02 40 40 40 40    . ! . . & . @ @ @ @
02 0D 1B 44 0A 14 1E 28 28 28    . . . D . . . . ( ( (
00 01 0A 41 0D 42 0A 43 43 43    . . . A . B . C C C
```

A period (.) is printed for each code that has no ASCII equivalent. During the hex dump, all commands except DLE EOT and DLE ENQ are disabled.

3-5 When the printing finishes, turn off the printer.

3-6 Turn on the printer and then the hexadecimal mode is off.

4. Specification

	Item	Details
Printer	Printing Method	Thermal Line Printing
	Dot Density	SRP-350plus: 180 dpi (7dots/mm) SRP-352plus: 203 dpi (8dots/mm)
	Printing Width	72mm
	Characters per line (Default)	SRP-350plus: 42 (Font A) / 56 (Font B) SRP-352plus: 48 (Font A) / 64 (Font B)
	Printing Speed *1)	SRP-350plus: 47.28 lines/sec, 200 mm/sec SRP-352plus: 52 lines/sec, 195 mm/sec
	Receive Buffer Size	4K Bytes
	SMPS Input Voltage	100~240 VAC
	Frequency	50/60 Hz
	SMPS Output Voltage	24 VDC
	Temperature	0 ~ 45 °C (Operating) -20 ~ 60 °C (Storage)
	Humidity	10 ~ 80 % RH (Operating) 10 ~ 90 % RH (Storage) ; Except for paper
	Auto Cutter	1,800,000 Cuts
	Mechanism MCBF *2)	70,000,000 Lines
	Paper	Paper Type
Roll Width		79.5±0.5mm
Roll Diameter		Max 83mm
Paper Thickness		0.062~0.075mm
Paper Tube		Inner: Ø12mm (0.47") Outer: Ø18mm (0.71")

※ Note

- * Printing speed may be slower depending on the data transmission speed and the combination of control commands.
- * The above values are calculated under printing level 2 with recommended paper at normal temperature. The values may vary with environment temperature, printing level, etc.
- * This equipment is indooruse and all the communication hiring are limited to inside of the building.
- * The switch is the disconnecting device. Turn off switch from any hazard.

5. Appendix

5-1 Cleaning Printer

Paper dust inside the printer may lower the print quality. In this case clean the printer as follows.

5-1-1 Open the printer cover and remove the paper if exists.

5-1-2 Clean the print head with a cotton swab moistened with alcohol solvent.

5-1-3 Clean the platen roller and paper end sensor with cotton swab moistened with water.

5-1-4 Insert a paper roll and close the printer cover.

The remained amount of paper detected by paper near end sensor varies with the diameter of the paper core.

To adjust the remained amount, contact your dealer.